

FloorNet: Deployment and Evaluation of a Multihop Wireless 802.11 Testbed

Pablo Serrano, Carlos J. Bernardos, Antonio de la Oliva, Albert Banchs, Ignacio Soto, Michael Zink

Abstract—A lot of attention has been given to multihop wireless networks lately, but further research—in particular, through experimentation—is needed. This attention has motivated an increase in the number of 802.11-based deployments, both indoor and outdoor. These testbeds, which require a significant amount of resources during both deployment and maintenance, are used to run measurements in order to analyze and understand the limitation and differences between analytical or simulation-based figures and the results from real-life experimentation. This paper makes two major contributions: *i*) first, we describe a novel wireless multihop testbed, which we name FloorNet, that is deployed and operated under the false floor of a lab in our Computer Science building. This false floor provides a *strong* physical protection that prevents disconnections or misplacements, as well as radio shielding (to some extent) thanks to the false floor panels—this later feature is assessed through experimentation; *ii*) second, by running exhaustive and controlled experiments we are able to analyze the performance limits of commercial off-the-shelf hardware, as well as to derive practical design criteria for the deployment and configuration of mesh networks. These results both provide valuable insights of wireless multihop performance and prove that FloorNet constitutes a valuable asset to research on wireless mesh networks.

Index Terms—802.11, mesh, 802.11a, 802.11g, experiments, testbed, measurements, COTS.

I. INTRODUCTION

Nowadays, there are many 802.11-based deployments, both indoor [1]–[5] and outdoor [6]–[8], this success being primarily motivated by the low cost and wide availability of Wireless LAN (WLAN) devices. These deployments are used for a variety of purposes, e.g.:

- To provide communication in rural areas [9]–[11].
- As a distributed infrastructure for the supervision of enterprise-sized WLANs [12], [13].
- To build community mesh networks, both by private companies or by universities [14], [15].
- As a research infrastructure to understand and assess the impact of the assumptions made by theoretical analysis, or wherein to develop heuristics and algorithms for network optimization and configuration [1], [4], [16].
- As a way of providing home networking [17].

P. Serrano, C. J. Bernardos, A. de la Oliva, A. Banchs and I. Soto are with Dept. Ing. Telemática, Univ. Carlos III de Madrid, Avda. Universidad 30, 28911 Leganés –Spain (email: {pablo, cjb, aoliva, banchs, isoto}@it.uc3m.es).

A. Banchs is also with IMDEA Networks, Avda. del Mar Mediterráneo 22, 28918 Leganés –Spain.

M. Zink is with Dept. of Electrical & Computer Engineering, Univ. Massachusetts Amherst, 151 Holdsworth Way, 01003 Amherst MA –USA (email: zink@ecs.umass.edu).

Although there is a widespread deployment of 802.11-based networks, research on all aspects of how to manage these deployments is still quite active, specially when they involve multi-hop wireless links. Most of the research on wireless networks has been based on simulation, but as highlighted above and because the field is becoming more mature, there is an increasing interest in experimental results from realistic testbeds. However, having realistic wireless testbeds is not an easy task. The cost of the equipment, the required physical space, the interference with other wireless networks, and the management and configuration of the testbed, are all burdens that have to be addressed by researchers (e.g., [2], our previous work of [5]).

In this paper, we present *FloorNet*, a research-motivated testbed that is comprised of 24 wireless routers which are installed under the false floor in one of the rooms of our Computer Science (CS) building. Out of the potential locations for such a medium-size testbed (e.g., wiring closets, lowered ceilings, private offices), we decided to deploy it under the false floor because of following reasons:

- Many CS / Information Technology (IT) buildings have false floors, which can be seen as an “unused” and “unclaimed” large space with a lot of room for cables and devices.
- This space is easily accessible but physically well protected, and therefore the risk of physical damage, disconnecting wires or even moving the equipment is null¹.
- In addition, this space is also provided with gridded power and wired network connectivity (sockets are usually uniformly distributed through the room).

Finding a convenient, simple and cost-efficient way to install a multihop wireless testbed is only one part of the challenge of building a realistic multi-hop testbed. In addition, a characterization of the testbed is required to determine how the environment (interference from other wireless devices, isolation through metal in the floor) can impact experiments. This is done for a series of single link measurements, i.e., only one wireless link between two routers is active at a time. Results from these experiments show that 802.11 devices can benefit from this isolation, depending on the surrounding sources of interference. We also assess the devices’ performance under large frame-per-second rates, and investigate if transmission power can be used as a means to emulate a variety of multi-hop scenarios in the testbed—which is indeed the case for 802.11a. Note that this feature results in the ability to change topology

¹Note that even slight changes in the relative location of the wireless devices can change the results obtained from the same experiment [18].

without physically moving the hardware or using attenuators.

With the above, we use our testbed to analyze two different *research scenarios*: first, we conduct extensive experiments in which two links are active simultaneously. Here our goal is to investigate how these two links interfere with each other based on channel distance and transmission power; second, we compare different channel and power allocation algorithms in a multi-hop configuration. Results from these experiments not only demonstrate the research capabilities provided by FloorNet, but also provide valuable insights of wireless multihop performance.

The rest of the paper is organized as follows: Section II describes the testbed, equipment, costs, and configuration; Section III analyzes the behavior of single links in the testbed; Section IV goes a step further and studies the behavior of pairs of links working simultaneously and how they influence each other; Section V analyzes the performance of multihop communications; Section VI lists the lessons learned during the set up of the testbed and the experiments; and finally Section VII concludes the paper.

II. DESCRIPTION OF FLOORNET

In this section we describe FloorNet, a wireless mesh testbed deployed under the false floor of one of the labs of our CS building, both technically and in terms of cost. We also assess the isolation provided by the false floor, as well as the performance limits of the hardware used.

A. Experimental setup

FloorNet is composed of 24 routers, as shown in Fig. 1. Since cost is a key factor that determines the feasibility of mesh deployments, we use commercial off-the-shelf (COTS) wireless routers to assess the performance that can be achieved with non-specialized hardware. In particular, we use 2 different devices:

- *Linksys WRT54GL v1.1*. This is a small and very popular home and office broadband router, equipped with a 200 MHz processor, an IEEE 802.11b/g WLAN interface and an IEEE 802.3 Ethernet interface connected to a Virtual LAN (VLAN) capable 5-port switch.
- *Asus WL-500GP v1.0*. This small residential router is equipped with a 266 MHz processor, an IEEE 802.11b/g WLAN interface and an IEEE 802.3 Ethernet interface connected to a VLAN capable 5-port switch. This version of the router has a mini-PCI slot that allows to change the original wireless card². We remove the original Broadcom card and insert instead an Atheros based 802.11a/b/g (Alfa Networks AWPCI085S) one. This card is supported by the Madwifi³ driver. Because of the different frequency band used by 802.11a, we exchange the original 2.4 GHz antenna for a dual-band and low gain (8 dBi) external antenna (Asus WL-ANT 168) for all the Asus routers.

The firmware of both types of routers can be replaced with an open source Linux-based firmware. We install the *OpenWRT*⁴ [19] Kamikaze 7.09 distribution with a Linux-2.4

kernel in the routers. This firmware gives us more flexibility in the use and configuration of the routers than the original firmware.

A wired interface of each of the routers is used to perform several control and management plane operations, such as the global synchronization of the local time of all the routers, the remote execution of tests and the retrieval of the results for off-line processing. Two central nodes (PCs, not shown in Fig. 1) are used to control and monitor all the routers of our deployment through the wired interfaces. They also serve as traffic source and sink for most of the tests (we assess the impact of the entity generating traffic in Section II-C). This way, management traffic does not interfere with the actual measurement data on the wireless medium. All the routers and the central nodes are connected to a pair of 24-port Gigabit D-LINK DGS-1224T switches (not shown in Fig. 1).

We use private addressing for all the network interfaces (wired and wireless). The particular addressing and routing can be changed by remote script execution from the central nodes. The wireless parameters (e.g., SSID, mode, transmission power, etc) can also be changed remotely. This allows us to dynamically modify the network topology as required by the different experiments.

We configure all the devices to use the country settings for Spain. This has an impact on the channels that can be used –Fig. 2 shows the 802.11a and 802.11b/g channels for Spain– and on the maximum allowed transmission power levels. We disable 802.11b compatibility mode in the Linksys routers by setting the `GOonly` flag, but we keep the devices’ rate adaptation [20] algorithms enabled. This way, we have a smoother transition between connectivity and no connectivity situations, while we avoid performance drops caused by the use of 802.11b compatibility mode in 802.11g networks [21].

B. Cost

One of the key features of FloorNet is that it is a cheap but powerful testbed. The following list gives an overview on the estimated cost of the equipment used:

- Linksys WRT54GL v1.1: 52€ per unit.
- Asus WL-500 GP v1.0: 75€ per unit.
- Alfa Networks AWPCI085S mini-PCI card: 36€ per unit.
- Asus WL-ANT 168 antenna: 22€ per unit.

In addition to the previous equipment, we only need a pair of Ethernet switches, the wiring, two PCs and a room with false floor (which is quite common in offices/laboratories where computer equipment is installed). With this deployment we are able to run automatized experiments with little human interaction and maintenance. An estimation of the overall cost of the testbed is 4200€.

C. Impact of the entity generating traffic

In our testbed, as described in Section II-A, we use PCs to generate traffic while wireless devices are used only to forward it to the final destination. This closely resembles real wireless deployments. An alternative configuration, that can be quite tempting, is to generate the traffic in the wireless routers, this

²Note that v2.0 does not provide this feature.

³<http://www.madwifi.org/>

⁴<http://www.openwrt.org/>

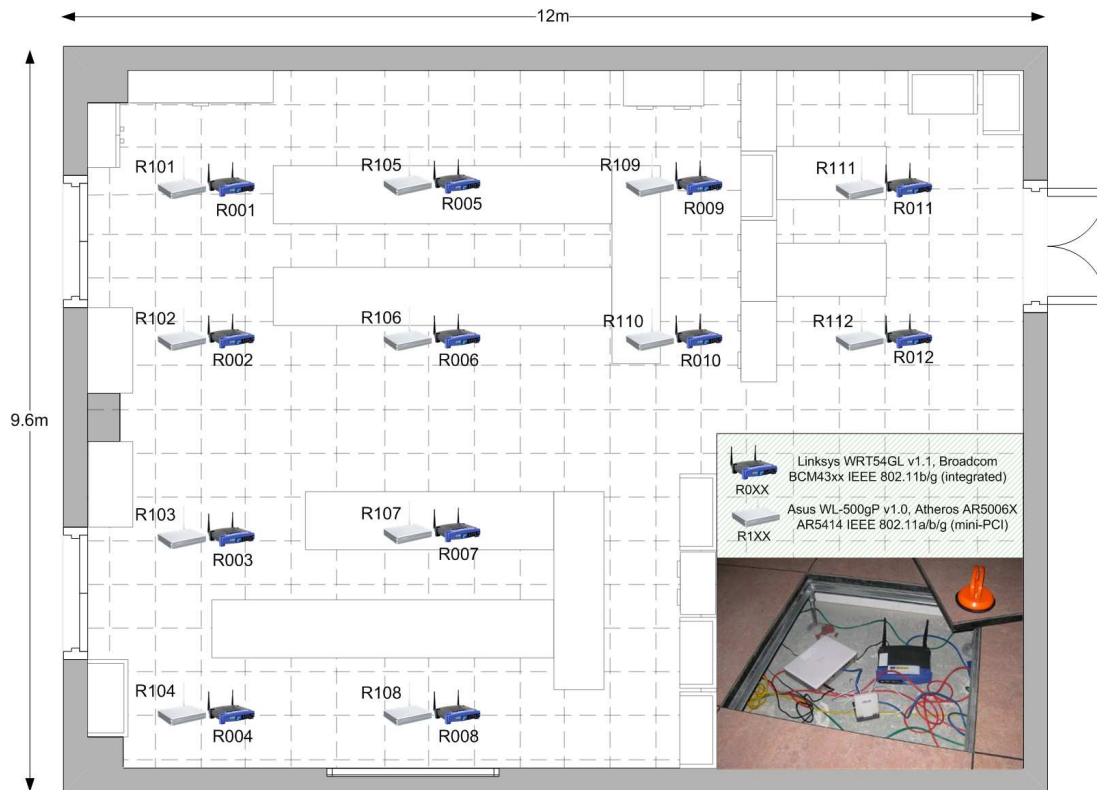

Fig. 1. Physical deployment of FloorNet.

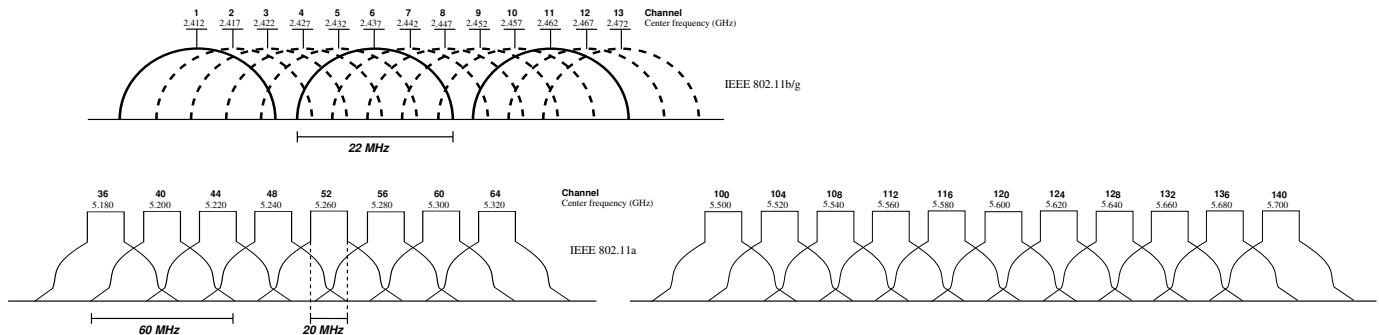

Fig. 2. Available 802.11g and 802.11a channels in Spain.

way reducing the equipment needed and the corresponding management operations.

This alternative configuration would be feasible only if generating the traffic in the wireless devices does not affect the behavior of the testbed. The concern is that traffic generation can impose a severe burden to the (typically small) capacity of the off-the-shelf devices used in the testbed. To assess the extent to which traffic generation can reduce the forwarding ability of these devices, we perform the following experiment. Using the PCs to generate traffic with `iperf-2.0.2`⁵, we measure the maximum UDP bandwidth achievable for different frame sizes (i.e., different frames per second). In this way, the frames generated by one of the PC are sent through the wired Ethernet to a first wireless device, that sends it over the wireless medium to the second device, that finally

forwards the frames to the receiving PC. The devices used were R104 and R108 for the case of Asus devices, and R004 and R008 for the Linksys devices (note that the experiments are not performed simultaneously).

After we finish this round of experiments, we repeat the measurement, but in this case using the wireless devices themselves to generate the traffic. This way, the frames are generated at the wireless router and sent over the wireless medium to be received at the other wireless device. We run these two configurations for three cases: *i*) using the Linksys devices, *ii*) using the Asus devices configured in 802.11g mode, and *iii*) using the Asus devices configured in 802.11a mode. We also measure using `cyclesoak`⁶ the

⁵<http://sourceforge.net/projects/iperf/>

⁶We had to download the source code of the tool from <http://www.tux.org/pub/sites/www.zip.com.au/~%257Eakpm/linux/zc.tar.gz> and cross-compile it to run on the MIPS architecture of the devices.

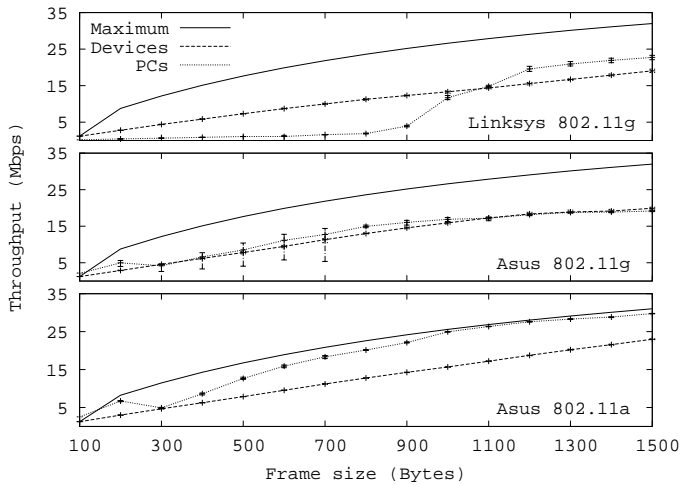

Fig. 3. Impact of using the wireless devices to generate traffic.

CPU utilization in all cases, this being always larger than 90% which confirms that the CPU usage is a limiting factor for throughput (however, note that the CPUs of the Linksys and the Asus have different capacity).

We perform the same measurement 5 times to obtain the average, maximum and minimum value. The results from these experiments, also compared against the maximum theoretical performance [22], are given in Fig. 3. We highlight the following results from these experiments:

- The entity used to generate traffic can have a significant impact on the performance. Therefore, in general it is not safe to generate traffic using COTS wireless devices and assume that the scenario is closely resembling the performance of real wireless deployments –in these, traffic is generated by the end hosts, while the devices are devoted to forwarding. In particular, for the cases of Asus 802.11a and Linksys 802.11g, the resulting performance is significantly different depending on the entity generating the traffic.
- On the other hand, for the case of Asus 802.11g the performance is very similar regardless of the entity generating traffic. Note that, for this case, the best performance obtained is well below the theoretical maximum, while for the case of Asus 802.11a the performance using the PCs is closer. Motivated by this result, we conjecture that the radio access is acting like a bottleneck that prevents the performance of the ‘PCs’ and ‘Devices’ cases to diverge.
- For the Linksys 802.11g case the relative performance of each approach depends on the frame size: for small frame sizes, the largest throughput is obtained using the wireless routers to generate traffic; for large frame sizes, the largest throughput is obtained using the desktop machines. We conjecture that this is caused because the Linksys is not able to cope with the processing burden of receiving-forwarding-transmitting a large number of small frames per second. On the other hand, the Asus router does not show this behavior.
- For the case of 802.11g and using large frame sizes and the desktop machines, the performance obtained with the

TABLE I
IMPACT OF THE FALSE FLOOR ON THE LINK PERFORMANCE.

Device	Tx Power	Above		Below	
		RSSI	Throughput	RSSI	Throughput
Linksys (802.11g)	1 dBm	-39.0	17.8 Mbps	-53.4	21.2 Mbps
	19 dBm	-28.0	19.5 Mbps	-42.3	22.7 Mbps
Asus (802.11a)	5 dBm	52.0	29.7 Mbps	46.4	29.8 Mbps
	17 dBm	73.4	29.6 Mbps	69.2	29.6 Mbps

Linksys devices is slightly larger than the one obtained with the Asus devices. We conjecture that the reason for this small improvement in the crowded 802.11g is that the Linksys is provided with two antennae for space diversity.

The main conclusion from the above results is that, indeed, the entity generating traffic can introduce a bias in the performance obtained, and therefore before running extensive measurements in a testbed great care has to be put in the performance assessment of the devices. Note that from now on all experiments are performed using a frame size of 1500 bytes and using the PCs to generate traffic.

D. False floor isolation

Apart from the physical protection, another key feature of our deployment under the false floor is that it should provide to some extent isolation from other 802.11 devices⁷. To assess the impact of this protection, we perform the following experiment for both the 802.11g and 802.11a devices. First, we put a pair of devices over the false floor (namely, the pair {R009, R010} for the case of Linksys, and the pair {R109, R110} for the case of Asus) and measure the throughput obtained with a UDP unidirectional communication for 30 seconds. We repeat the measurement 5 times for two values of the transmission power. We also record the RSSI value⁸ reported by the wireless device. Next, we place both devices under the false floor, and repeat the process. The average values of the 5 runs for each configuration are presented in Table I.

Out of the results of the table, it is clear that the false floor has some impact on the values obtained for each configuration. Considering throughput, the results can be summarized as follows:

- For the case of 802.11g, the throughput values obtained when both devices are placed under the false floor are noticeable larger (> 15%) than when both devices are above the floor.
- For the case of the 802.11a devices, however, there is no difference in terms of throughput between the configurations.

Therefore, it seems that the false floor provides, at least for the case of the Linksys devices, a *better* environment for the performance of experiments⁹. For 802.11a, on the other

⁷Note that the false floor in our laboratory is composed of two thin metal layers separated by a 2 cm chipboard layer.

⁸RSSI, Received Signal Strength Indication, is a measurement, reported by the receiving device, of received signal strength. The value of RSSI is vendor dependent and has not units.

⁹We performed additional experiments to assess the ability of the false floor panels to attenuate a wireless communication, and indeed crossing the false floor resulted in a throughput degradation of approximately 30% for both the 802.11a and 802.11g cases.

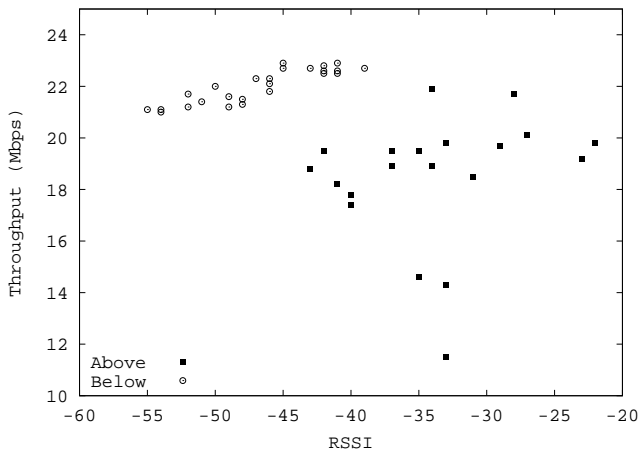

Fig. 4. Performance of a single 802.11g link above and below the false floor.

hand, there is no difference – a result that one could expect in advance, given that while the 2.4 GHz is crowded, there is less activity in the 5 GHz band (we will further verify this in Section III-A).

Considering the reported RSSI values of Table I, a first (and expected) result is that, for the same scenario, the larger the transmission power used, the larger the RSSI. However, there is a second and non-intuitive result: *the RSSI values are smaller when both devices should have been “shielded” by the false floor*. Furthermore, for the case of the Linksys devices using 802.11g, there is an apparent contradiction: for the largest RSSI value, the throughput is smaller than for the smallest RSSI value.

To analyze this result, we repeat the experiments for the Linksys devices, considering 5 different values for the transmission power (namely: 1, 5, 10, 15 and 19 dBm). Each measurement is repeated five times. Then we plot the values of throughput obtained vs. the reported RSSI values in Fig. 4, where we use circles to represent values when both devices are below, and black squares to represent values when both devices are above the floor. We observe the following results:

- When both devices are *below* the false floor, the throughput values are larger and present less variability, and there seems to be a small positive correlation with the RSSI value – this would be the “expected” behavior in interference-free environments, as proved in [23].
- When both devices are *above* the false floor, indeed the RSSI’s reported are larger, but there is more variation both in the RSSI values and in the throughput obtained (which is smaller than when both devices are below the false floor).

The behavior where both devices are above the false floor corresponds to an interference-prone scenario¹⁰ (like, e.g., RoofNet [7]) that suffers from “RF-pollution” (as discussed in [23]). This is causing a *bias* in the measurement of the RSSI values: only those packets successfully received are considered. Out of these measurements, therefore, we derive two main conclusions: *i*) the false floor does provide FloorNet with

¹⁰In the next section we will further confirm the presence of other 802.11g sources.

some shielding from external sources, and *ii*) for indoor testing one has to be cautious when relating RSSI and throughput.

III. SINGLE LINK MEASUREMENTS

In this section we run extensive experiments to characterize the performance limits of the wireless links that can be used with FloorNet. To this aim, we first measure the achievable performance at each channel through 24-hour measurements for the maximum transmission power, and then we analyze the impact of the transmission power used on the throughput experienced by each link. The results obtained prove the variety of scenarios that can be emulated with FloorNet.

A. Impact of the time of the day

In order to calibrate the testbed and check for possible interference sources which may affect the results presented in the following sections, we measure the performance obtained with both the 802.11g and 802.11a devices during a 24-hour period. The results from this analysis will be used to select the time frame in which our measurements are more protected from external interference.

First, we analyze the performance of a unidirectional wireless communication between two Linksys devices using 802.11g. To that aim, we use `iperf` to generate traffic from one desktop machine to the other desktop machine, using the wireless link between the devices R011 and R012 (see Fig. 1). The traffic generated consists of a UDP flow of 35 Mbps, using frames of 1500 bytes during an interval of 30 seconds. In order to test every possible channel, after each 30-second sample the channel used is changed to the next one, using the full set of available channels in Spain which span from channel 1 to channel 13 (see Fig. 2).

The results obtained are shown in Fig. 5, where we plot the bandwidth obtained and the frames from other traffic sources observed during the experiment. The maximum theoretical achievable bandwidth for IEEE 802.11g and for a packet size of 1500 bytes is above 30 Mbps [22]. As shown in Fig. 5, this maximum achievable bandwidth is never obtained.

Results from this test for a 24-hour time span can be summarized as follows:

- The achievable bandwidth varies between two distinct states. The first state corresponds to bandwidth rates in the order of 20-25 Mbps, spanning between the nighttime up to 9h and between 14h and 18h. The second state corresponds to lower bandwidth rates, between 10 and 15 Mbps, spanning between 9h and 14h and between 18h and 21h.
- In the first state (from 21h to 9h and from 14h to 18h), the performance is quite stable. Note that the achieved bandwidth is approximately the same at night hours than from 14h to 18h. To relate performance to the influence of external interference sources, we also plot in Fig. 5 the number of frames from traffic sources other than ours. This graph shows how the number of frames detected is quite high, explaining the constant drop in performance across all the results, also showing how the number of frames is quite stable during night and slightly more

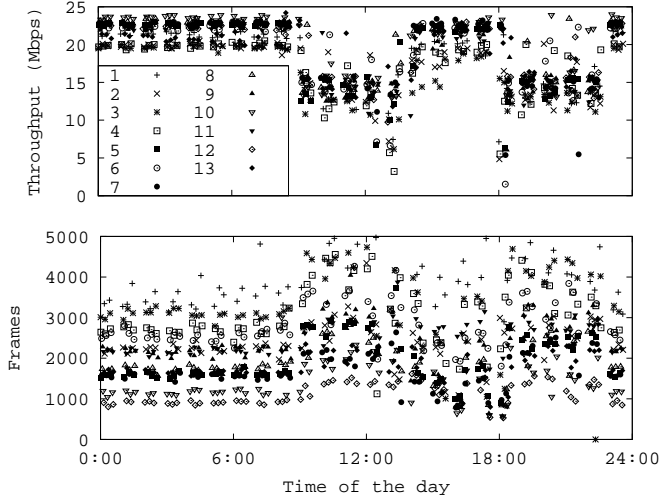

Fig. 5. Performance of 802.11g in our testbed.

unstable from 14h to 18h. This amount of interference is due to the fact of the testbed being deployed in a CS lab, where interference sources are always active, even at night, corresponding to the different ubiquitous WLAN networks of the building.

- In the second state (from 9h to 14h and 18h to 21h) performance is quite unpredictable. During these periods of time, the number of frames from external sources increases, showing also the instability trend across all channels. We argue that this time period matches perfectly with the schedule of the undergrad students using the lab for research activities (e.g., Bluetooth devices): students arrive at 9h, working until lunch time (14h), and resuming after classes from 18h to 21h.

We conclude that the presence of external interference in the 2.4 GHz band is unavoidable, even for our testbed deployed under the false floor (that, as we saw in Section II-D, provides some isolation).

We next repeat the experiment but for the 802.11a case, using the Asus devices (R111, R112). The experimental methodology is exactly the same as for 802.11g but the channels used span between 36–64 and 100–140, as shown in Fig. 2. Results are given in Fig. 6. As expected, 802.11a channels provide a better and more stable performance, since 802.11a is not commonly used in Spain and, furthermore, the false floor provides noticeable isolation. The results show an almost-constant achievable bandwidth of approximately 28.7 Mbps, while there are practically no frames from external sources.

We conclude that while results from 802.11a measurements do not depend on the time of the day, for the case of 802.11g “office hours” can introduce a significant bias. Therefore, the rest of 802.11g experiments are run during nighttime to lessen the impact of interference, while there is no need to careful plan 802.11a experiments¹¹.

¹¹We note, however, that for some wireless experiments it may be useful to run experiments during working hours to, e.g., assess the sensibility of a given protocol to interference.

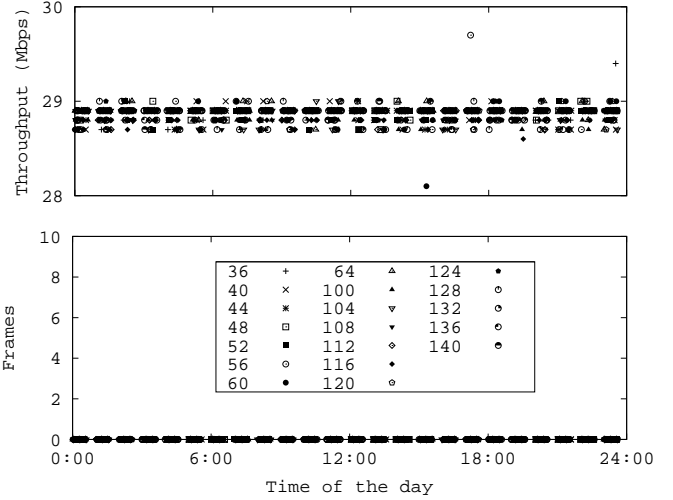

Fig. 6. Performance of 802.11a in our testbed.

B. Impact of the transmission power

One of the key features of a research testbed is its ability to emulate a large variety of multihop scenarios. In this section, we show that, despite being deployed under the false floor, the degree of connectivity of FloorNet nodes can be easily controlled through the transmission power of the wireless interfaces. To measure the ability of the transmission power to modify the connectivity pattern in our testbed, we run the following experiment. We first set all the N nodes of a given physical layer (802.11g or 802.11a) to use the same transmission power. Then, for each of the $N \times (N-1)$ available links, we measure the bandwidth obtained for a 30-second UDP unidirectional run. That is, for each of the 12 Linksys or Asus nodes, we measure the bandwidth between that node and each of the other 11 nodes, with only one link active at a time. Note that with 12 nodes we have a total of 132 unidirectional links. We repeat each measurement 5 times, and compute the average, minimum and maximum values of throughput per link. Then we sort the resulting list of average bandwidth rates from largest to smallest and plot the results. The experiment is repeated for different transmission power levels, with the results for 802.11g depicted in Fig. 7 and the results for 802.11a in Fig. 8. (In each figure we plot the minimum and maximum values obtained every 10 links for clarity reasons.)

Fig. 7 shows that a high degree of connectivity is achieved in 802.11g even with the lowest transmission power. Actually, most of the results overlap, and changing the transmission power affects the performance of only about 30% of the links. This means that 802.11g, with its larger transmission range, does not support the creation of diverse layer-2 connectivity patterns in our testbed.

The situation in 802.11a, as shown in Fig. 8, is very different. By using various transmission power levels we can modify the connectivity of different nodes in the testbed. Note that even at the maximum power not all the nodes are directly connected. Another important consideration is that the plot shows quite steep slopes, which means that by varying the transmission power we can easily change the state of several links, ranging from a no-connectivity state to maximum

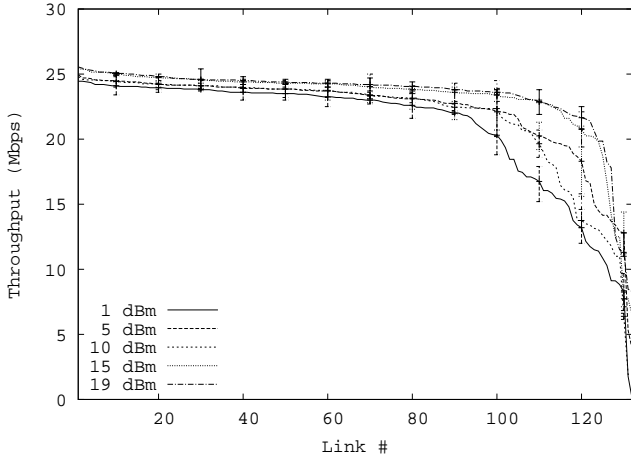

Fig. 7. Impact of the transmission power on the connectivity of the 802.11g testbed.

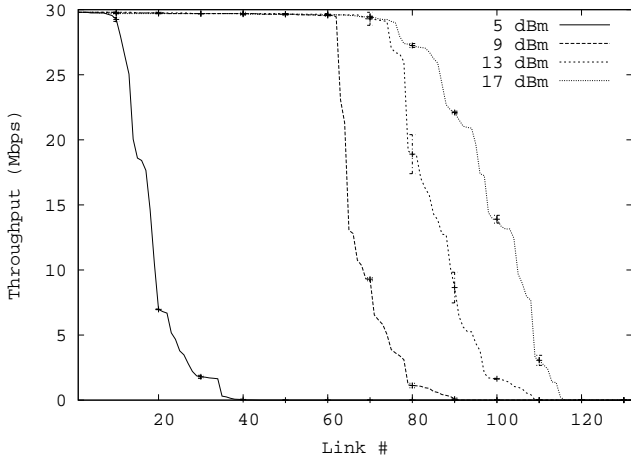

Fig. 8. Impact of the transmission power on the connectivity of the 802.11a testbed.

performance throughput. Therefore, the main conclusion is that in our 802.11a testbed we can use the transmission power to set up different direct link connections between the nodes involved, enabling the generation of diverse multi-hop topologies¹².

During the measurements we also sample the RSSI reported by the receiving device. Then we plot in Fig. 9 (for 802.11g) and Fig. 10 (for 802.11a) the relation between the bandwidth and the relative quality measurement. Both figures show that once a certain RSSI is achieved, we get the maximum bandwidth in the link, and therefore (because of the shielding provided by the false floor) it can be used to predict the link performance (as reported in [11]). In both cases the slopes are steep, so this confirms the previous conclusion that by varying the transmission power we can change from having no connectivity to a maximum throughput link. Another interesting consideration is that the dispersion in 802.11g is larger than in 802.11a: while in 802.11a, for a large range of values of RSSI we have a very stable high bandwidth, in 802.11g we have much more variation in the bandwidth achieved.

¹²These results are consistent with the simulation study in [24] about the differences in coverage and bandwidth between 802.11a and 802.11g.

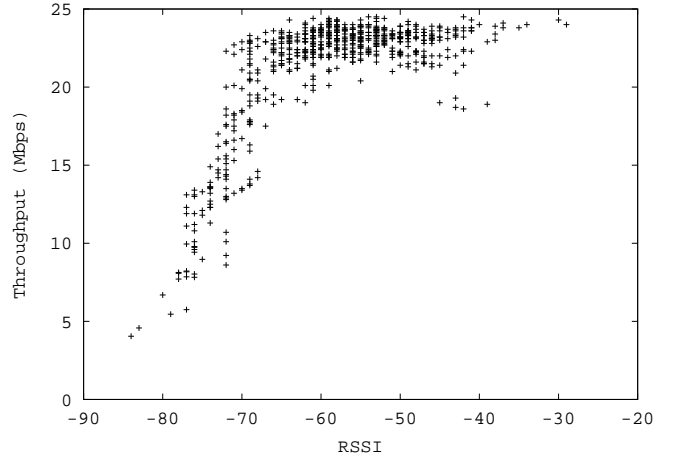

Fig. 9. Relation between the obtained bandwidth and the reported RSSI by the 802.11g devices.

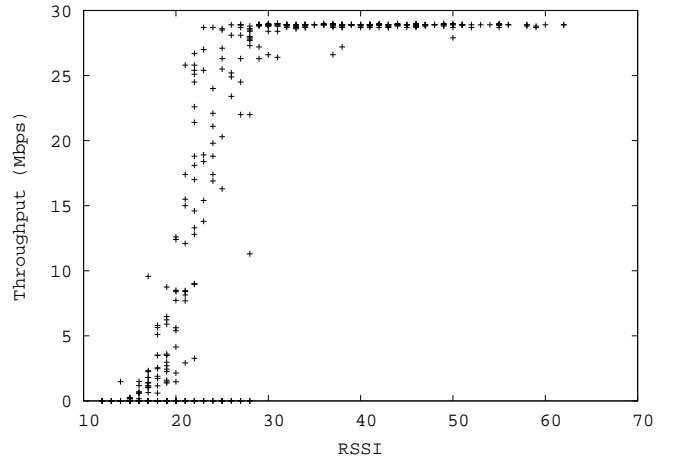

Fig. 10. Relation between the obtained bandwidth and the reported RSSI by the 802.11a devices.

IV. TWO LINKS MEASUREMENTS

In this section, we take advantage of our testbed to run extensive automatized experiments to analyze deployments where two different links are active at the same time. More specifically, as a *use case* of FloorNet we will aim at deriving a set of “configuration rules” in order to maximize the performance of multiple link scenarios. To that aim, we consider the following two possible scenarios, illustrated in Fig. 11:

- Far In this case, the relative distance between each transmitter and its intended receiver is much less than the distance between the potentially interfering node.
- Close Here we have the opposite situation: the potentially interfering node is much closer than the receiver of the transmission.

Note that we are talking about relative distances between the sender, the intended receiver and potential interferer(s). Still, in all cases the absolute distances between each pair of devices are substantially larger than the far-field threshold, to prevent close-field interference (as reported by, e.g., [25]). This

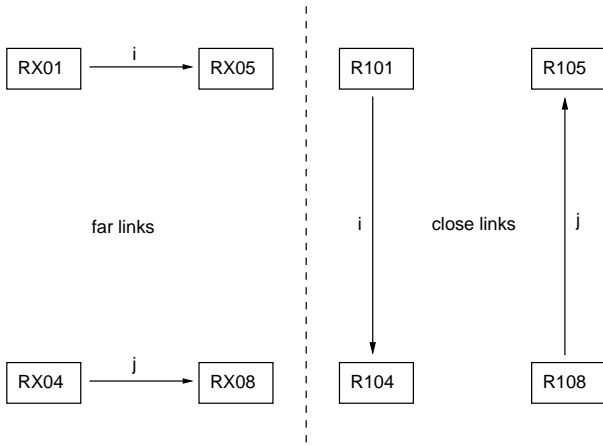

Fig. 11. Far links (left) and close links (right) scenarios.

far-field threshold d is given by [26]:

$$d = \frac{2D^2}{\lambda}$$

where D is the antenna diameter and λ is the wavelength of the radio wave.

A. 802.11g – Far links

We first analyze, with our 802.11g devices, the case where the potential interfering source is far away, i.e., the scenario on the left side of Fig. 11. We consider three different configurations, *a*) both links i and j are using channel 13, i.e., channel distance $d = 0$; *b*) the channels are configured at a distance $d = 5$, more specifically, link i uses channel 13 and link j uses channel 8; and *c*) the configured channels are 13 and 3, respectively, resulting in a channel distance $d = 10$. For each of these configurations we change the transmission power each device is using, from 1 dBm to 19 dBm in steps of 2 dBm, and measure four different throughput rates:

- R_{single}^i (R_{single}^j): the bandwidth measured in link i (link j) when only one link is active.
- R_{both}^i (R_{both}^j): the bandwidth measured in link i (link j) when the two links are active.

The above is repeated 5 times. We then plot in Fig. 12 the sum of the bandwidth for both links when they are transmitting simultaneously ($R_{both}^i + R_{both}^j$) or at different times ($R_{single}^i + R_{single}^j$), for the three different channel separation scenarios (we also plot in the figure the minimum and maximum values measured). Note that the comparison of these two metrics is a proper estimation of the impact of the interference between the two links. Indeed, in absence of interference the two sums will take the same value, while in case the links interfere with each other, the sum of bandwidth rates will be smaller when both links are simultaneously active ($R_{both}^i + R_{both}^j$) than when they are not ($R_{single}^i + R_{single}^j$).

From the results shown in Fig. 12, we make the following observations:

- The transmission power does not have a noticeable impact on the performance, as all values look relatively flat (apart from a “notch” at 7 dBm that we will analyze next). Note

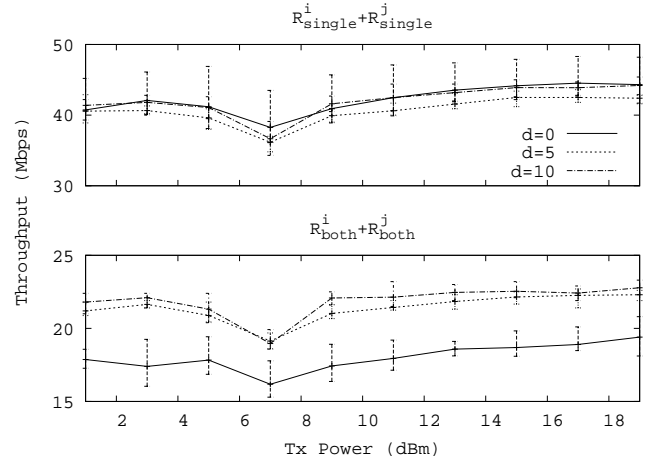

Fig. 12. 802.11g links: Impact of the channel distance and transmission power on the total throughput.

that these results could be expected, given the little impact of the transmission power on the variety of links that we already observed in Fig. 7.

- Both channels interfere, regardless of the configuration used. Note that for $d = 0$ the assumed behavior would be a channel sharing of approximately 50% (depending on the *capture effect* and the efficiency of the CSMA/CA mechanism), and indeed this is approximately the case: together, the sum of rates is approximately 18 Mbps, while in case they do not transmit at the same time the total throughput is around 40 Mbps.
- On the other hand, the cases of $d = 5$ and $d = 10$ are quite unexpected as non-overlapping channels (see Fig. 2) are assumed to not interfere at far distances, but we find that instead they do severely interfere with each other¹³.

Motivated by the “notch” at 7 dBm, we next extensively analyze the performance of a single link for different values of the transmission power used. To this aim, we run the 30-second UDP tests between two devices for a sweep of the values of the transmission power between 5 dBm and 10 dBm, and repeat the experiment 10 times. The results of each measurement are depicted in Fig. 13. Indeed, the figure shows that the Linksys devices introduce a drop in performance when using a transmission power close to 7 dBm: even the best performance out of 10 measurements for the {6,7,8} dBm values is well below the worst performance of the other values. Therefore, not only the Linksys devices interfere with each other when using non-overlapping channels, but also they can introduce a bias in performance depending on the values of the transmission power used.

The key conclusions that we draw from the above experiments using the off-the-shelf 802.11g equipment are: *i*) the equipment suffers from severe interference, even when non-overlapping channels are used, and *ii*) there is an unexpected drop in performance that depends on the transmission power

¹³We repeated the experiment for different configurations of the channels used in links i and j obtaining similar results.

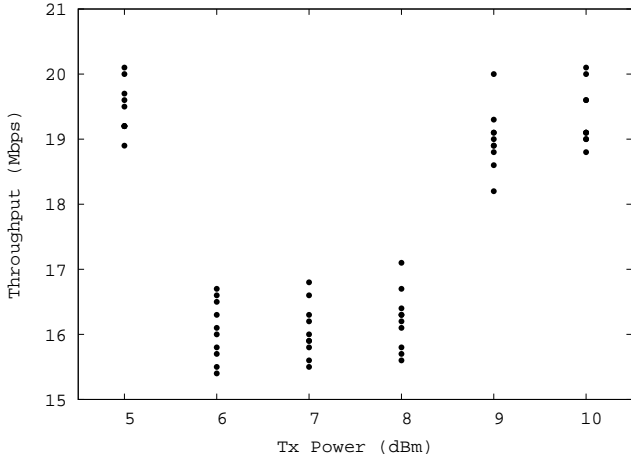

Fig. 13. Impact of the transmission power configured on the performance of a single 802.11g link.

used¹⁴. Despite the fact that it is well-known that multi-interface devices typically suffer from inter-card interference (see, e.g., [25], [27], [28]), our results are indeed unexpected as devices are placed at distances larger than the far field threshold. Furthermore, we have not found in the literature any reference to this faulty performance that depends on the configured transmission power. These results, that constitute part of the main contributions of the paper, adds to the growing evidence of deviations from expected behavior of off-the-shelf 802.11 devices (e.g., [18], [29], [30]).

Based on these results, as well as on the external interference in the 802.11g band that we observed in the experiment of Section III, we conclude that (at least with our equipment) 802.11g is not well suited to derive general configuration rules for the design of mesh networks. Following this conclusion, in the rest of the paper we focus on the 802.11a technology only.

B. 802.11a – Far links

Following the previous section, we next focus on understanding the impact of the interference in 802.11a when the potentially interfering nodes are relatively far away. To this aim, we first repeat the experiment reported above for 802.11a. The results of this experiment are plotted in Fig. 14.

We can see from the figure that the behavior is quite different from the one observed with the 802.11g devices. In particular, we observe:

- First, the transmission power used does have a noticeable impact on the performance. Indeed, for 5 dBm the connectivity is quite poor, and only for 13 dBm the maximum throughput is reached. Note that this is quite in line with the results from Section III-B, where it is apparent that 802.11a shows a larger sensitivity to the power used.
- When there is no channel separation ($d = 0$) and the transmission power is above 12 dBm, using both links at the same time results in a performance drop of

¹⁴We repeated the measurements using different pairs of Linksys devices and we obtained similar performance. We also measured the reported RSSI values, and they did not show any relation with the transmission power used.

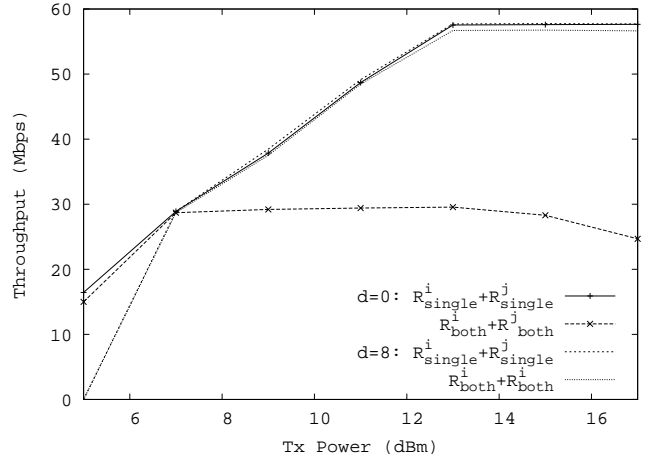

Fig. 14. 802.11a links: Impact of the channel distance and transmission power on the total throughput.

approximately 50%, as the total throughput obtained is around 25 Mbps while the sum of the rates each link would obtain independently is approximately 58 Mbps.

- For the case of complete channel separation ($d = 8$), we have the expected behavior that there is no interference between links, but only a negligible performance drop – due to the increased radio activity.

Therefore, as opposed to the 802.11g case, with 802.11a channels there is indeed a clear channel separation. In particular, a key conclusion is that *the observed behavior matches the expected theoretical one* as there is no interference among non-overlapping channels.

The above experiments focused on two channel separation values, namely $d = 0$ and $d = 8$. In order to gain insight into the performance with other distances ($d = \{0, 4, 8, 12\}$), we proceed as follows. We define the ratio η as the efficiency provided by a given channel separation¹⁵:

$$\eta = \frac{R_{both}^i + R_{both}^j}{R_{single}^i + R_{single}^j} \quad (1)$$

Note that the above metric should be 1 in absence of interference and close to 0.5 in case of strong interference, corresponding to an equal sharing of the channel's bandwidth. The results for η are shown in Fig. 15, with the following observations:

- For frequencies separated a distance $d = 8$ or larger, there is a small performance drop of approximately 2%, which confirms the previous result and shows that for this distance as well as any larger distances the interference between channels is negligible.
- The use of channels that overlap ($d = 4$) leads to a performance drop of approximately 10% ($\eta = 0.9$). Despite it is obvious that overlapping channels should reduce the overall performance, this performance drop is quite small as compared to $d = 0$. This shows that although there is some penalty paid by using overlapping

¹⁵Note that these types of throughput ratios have been used before to estimate interference, see [31].

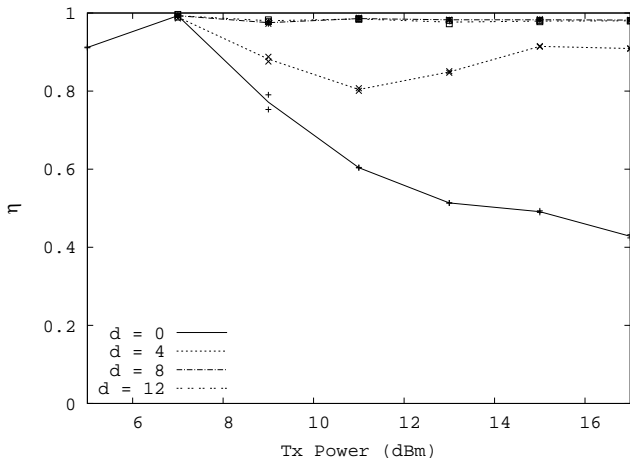

Fig. 15. Far links, 802.11a: impact of channel separation and transmitted power on channel efficiency.

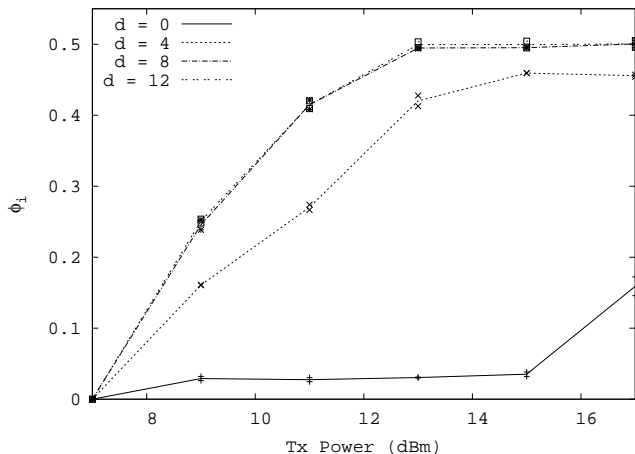

Fig. 16. Far links, 802.11a: impact of channel separation and transmitted power on throughput.

channels, the resulting interference does not strongly impact the performance (this is a result that we will further explore in Section V).

- Finally, when there is no channel separation ($d = 0$) the sensitivity of 802.11a to the received power results in a large dependence of η with the transmission power used, that ranges from $\eta = 1$ to $\eta = 0.4$.

The last result for $d = 0$ is somehow surprising and deserves more attention. Indeed, while we could have expected a 50% penalty due to interference, in Fig. 15 there is no loss of efficiency for the 7 dBm case. To further explore this result, we introduce the following fairness measurement:

$$\phi_i = \frac{R_{both}^i}{R_{both}^i + R_{both}^j} \quad (2)$$

With this ratio we are able to identify asymmetries in the links performance if results deviate from the reference value of 0.5 (i.e., both links get the same bandwidth). The results for the same configurations of Fig. 15 are depicted in Fig. 16. Indeed, with the aid of ϕ_i it is possible to get insights on channel performance:

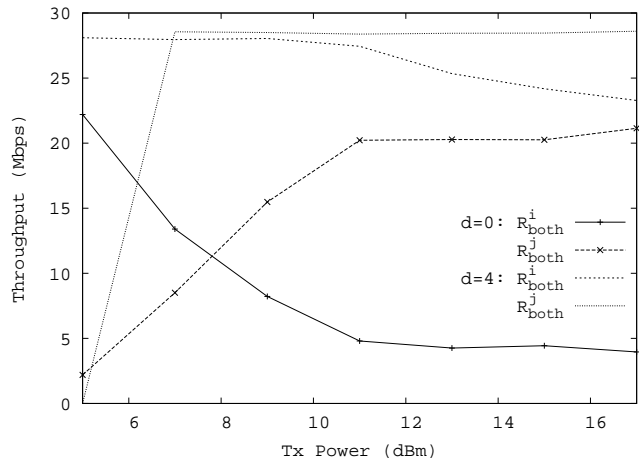

Fig. 17. Impact of channel separation and transmitted power on bandwidth share.

- Despite Fig. 15 shows that, regardless of the transmission power used, there is almost no loss in η for distances $d = \{8, 12\}$, this result is deceiving: the values of ϕ_i in Fig. 16 proves that until 13 dBm link j is getting most of the bandwidth. We conclude that below this power, link i is suffering from low radio conditions, and therefore those configurations should be avoided.
- The use of overlapping channels ($d = 4$), again, provides better values than the case of $d = 0$. For the former there is a slight asymmetry (around 0.45) at the maximum transmission power, while for the latter the best value is around 0.15. Therefore we conclude that, due to the sensitivity of 802.11a links to channel conditions, capture effect is quite common and any channel separation helps to lessen its effects.

With the above, we have seen that with the use of η and ϕ_i it is possible to assess the performance of different channel configurations when the transmission power is the same on both links, in order to find the best configuration. One remaining question is whether the use of different transmission power could lead to performance improvements. To this aim, we explore the unfair cases ($d = \{0, 4\}$) that apparently suffer from asymmetric radio link conditions, and perform the following experiment. We set a transmission power of 17 dBm on the link that obtained the smallest share of bandwidth (the *weak* link), and perform a sweep on the transmission power of the other link (the *strong* link), measuring the bandwidth each link obtains when both are active at the same time. The results are depicted in Fig. 17.

The results confirm that the observed asymmetry is due to the different channel conditions, as the links experience the same throughput only for different transmission power. For the case of $d = 0$, this occurs when the second link is using approximately 8 dBm, i.e., the difference in the transmission power is around 9 dB (despite the physical deployment is quite similar for the two pair of routers). On the other hand, for the case of $d = 4$ instead of a single point there is a range of transmission power (approximately, 7–11 dBm) that leads to similar bandwidth performance. Therefore, for this setting, a

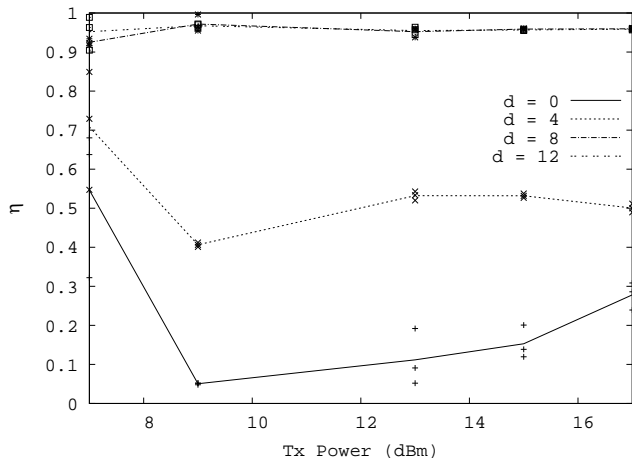

Fig. 18. Close links, 802.11a: impact of channel separation and transmitted power on channel efficiency.

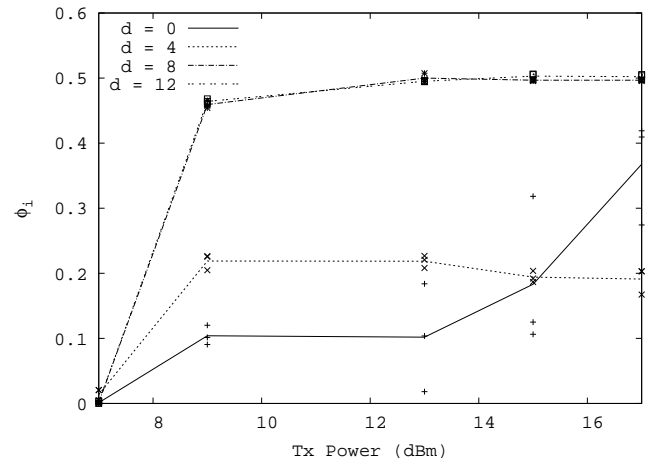

Fig. 19. Close links, 802.11a: impact of channel separation and transmitted power on bandwidth share.

careless power configuration provides the best performance using non-overlapping channels, while this requirement can be relaxed if the transmission power is carefully tuned. We will revisit this claim in Section V.

C. 802.11a – Close links

The previous conclusions have been derived when the potentially interfering node(s) are placed relatively far (i.e., farther than the intended destination). We next assess to what extent the performance can change in case the interfering node is *closer* than the destination¹⁶. To that aim, we consider the “close links” scenario of Fig. 11 and compute the values for η and ϕ_i for different values of the transmission power, with the results shown in Figs. 18 and 19.

For the case of completely separated channels ($d = \{8, 12\}$), it is clear that the results show a similar behavior to the far links case. However, when there is partial overlapping ($d = 4$) or no channel separation at all ($d = 0$), there are significant differences between the two cases:

- With close links, there is some additional performance loss as compared to the far links case when there is no channel separation ($d = 0$). In particular, the η values obtained are smaller than for the far links scenario starting from 7 dBm when both links are active. The explanation for this behavior is the fact that the *capture effect* does not help to improve performance but rather it worsens it: in case of a collision, the “surviving” frame will be the one from the closest sender, i.e., the one from the interferer (and therefore will be discarded by the non-intended receiver).
- In addition to the above, we further observe that with close links we obtain better fairness, with a ϕ_i value that almost reaches 0.4 for the maximum transmission power. This is explained by the fact that having both frames discarded in case of a collision helps to improve the fairness.

¹⁶Note that this setting should not be common in realistic mesh deployments, but because of physical constrains it could be that it is the only possible configuration.

- On the other hand, the use of partially overlapped channels does not have the same benefits as in the far links scenario. Indeed, while in the far links case we had an efficiency of $\eta > 0.9$, in this case the overall efficiency also drops approximately to 50%. Furthermore, this reduction comes also with a performance drop of ϕ_i , that while in Fig. 16 could reach values $\phi_i \geq 0.4$, for this case they do not deviate significantly from 0.2.

From the experiments reported in this section we conclude that with the use of the 802.11g devices there is little to gain from a careful deployment and parameter tuning, since we have a degraded performance regardless of the configuration of these parameters. However, 802.11a devices follow the expected behavior and substantially benefit from careful planning, and therefore pave the way for the analysis and design of optimal configuration strategies. In fact, we have just seen that for the case of two links configuration, depending on the relative distances between nodes some configurations might be worth exploring like, e.g., tuning the transmission power to save channel spectrum in the far links scenario.

V. MULTIHOP MEASUREMENTS

Armed with the results from the previous single and two links experiments, we now address the case of an 802.11a multihop wireless mesh. To that aim, we configure the routing tables of the desktop machines and the routers to build the topology illustrated in Fig. 20, that consists of up to 6 wireless hops. Note that the maximum performance achievable should be bounded by the best performance obtained for the case of single 802.11a links, i.e., approximately 29 Mbps (see, e.g., Fig. 6).

Next, we first assess the impact of channel configuration in that scenario. To that aim, we run a 30-second UDP test between the desktop machines through the 6 wireless hops, and measure the bandwidth at the end of each hop. We initially do this for the following three different “naïve” channel allocation strategies (all of them with the transmission power always set to 17 dBm):

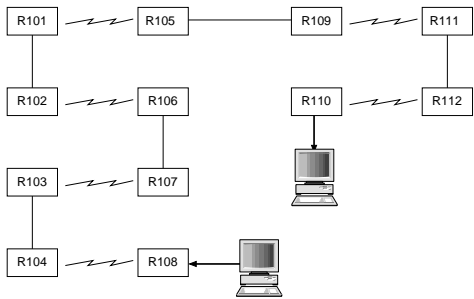

Fig. 20. Multihop scenario.

TABLE II
SPECTRUM EFFICIENCY OF EACH CONFIGURATION.

d	# Channels	Throughput	Performance
0	1	153 Kbps	0.00255 bps/Hz
4	6	6.9 Mbps	0.04313 bps/Hz
8	11	26.1 Mbps	0.10039 bps/Hz

- $d = 0$: in this case, all the links use the same channel; because of the resulting interference, we do not expect the performance of this configuration to be optimal.
- $d = 4$: for this strategy, the first wireless link is configured on channel 100, the next wireless hop uses channel 104 and so on, until channel 120 is assigned on the last 802.11a hop. Note that with this configuration there is partial overlapping between consecutive links. Therefore, also for this case, the performance may be far from the maximum achievable value.
- $d = 8$: in this resource-aggressive strategy, each link is configured on non-overlapping channels, with no frequency overlap or reuse. Note that for this last case, the only limiting factor is –at least, in principle– the ability of the 802.11a devices to forward traffic from the wired to the wireless interface, and therefore we would expect to achieve maximum performance.

The results for the above three approaches are shown in Fig. 21. We observe that, as expected, the most spectrum consuming approach ($d = 8$) provides the best performance with 26.1 Mbps. The partially overlapping configuration ($d = 4$) shows quite a poor performance, around 25% of the maximum achieved performance. Furthermore, the approach that uses the same channel for all links ($d = 0$) leads to almost null throughput. Note that this last result confirms the finding of [32], which observed that throughput drops to zero in a single-channel scenario. This is caused because the first station occupies the channel all the time without giving the second station any channel time, and therefore traffic gets stacked at the second station (which matches indeed with the results that we get in Fig. 21).

Since the number of channels used by the above approaches is different, in order to make a *fair* comparison between them, we compute in Table II the efficiency in terms of bps/Hz provided by each approach. According to the results obtained, we observe that the non-overlapping approach ($d = 8$) not only provides the best performance in terms of throughput, but also in terms of spectral efficiency. Therefore, for these “naïve” configurations where the transmission power is set to

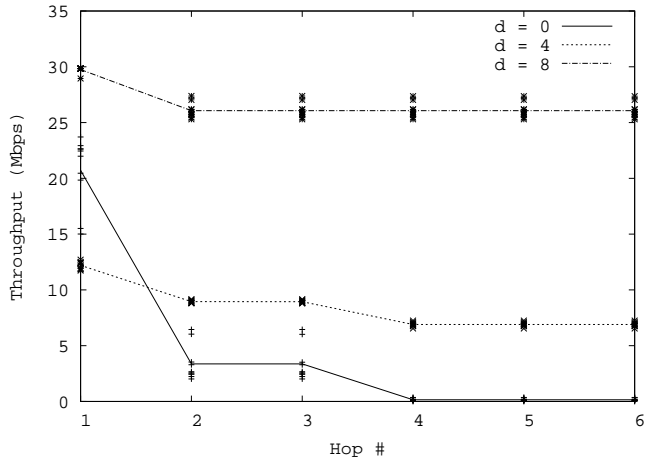

Fig. 21. Performance of multihop, 802.11a, 17 dBm.

Algorithm 1 Heuristic for the configuration of the multihop scenario.

- 1: Configure the transmission to transverse only link 1.
- 2: Set channel 100 on link 1
- 3: Search on the $\{TxPower\}$ values for the best throughput
- 4: Configure link 1 with the best TxPower found in Step 3.
- 5: **for** Link # i from 2 to 6 **do**
- 6: Configure the routing to also transverse link i
- 7: **for** Channel $\in \{100, 104, 108, 112, 116, 120\}$ **do**
- 8: **for** TxPower $\in \{8, 11, 14, 17\}$ dBm **do**
- 9: Save the channel and TxPower that provides the best performance
- 10: **end for**
- 11: **end for**
- 12: Set link i to use the best channel and TxPower
- 13: **end for**

the maximum value, we conclude that there is little motivation for the reuse of parts of the spectrum. However, motivated by the results from Section IV-B, as well as previous work considering multi-WLAN deployments [33], [34], we also want to assess if a more careful adjustment of transmission power and channel allocation can lead to a performance improvement. In particular, we investigate if, by using a less naïve strategy to adjust transmission power and to choose the channel frequency, a better spectral efficiency for the $d = 4$ configuration (i.e., using a total of 6 channels) can be achieved. To that aim, we have designed the heuristic described in Algorithm 1. Note that the heuristic reduces the search space by configuring each link in a hop-by-hop approach, and therefore we are aiming at a configuration that, although suboptimal, requires affordable configuration time¹⁷.

The list of channels and transmission power assigned per link resulting from applying the above algorithm¹⁸ are: $\{100, 116, 108, 120, 112, 104\}$ and $\{8, 11, 17, 17, 8, 14\}$ dBm, respectively. Note that the configuration found is quite different

¹⁷An exhaustive search for this scenario would require running experiments for more than 20 days.

¹⁸To reduce the running time, we only considered four values for the transmission power and never below 8 dBm, motivated by our previous results.

from the one in our naïve approach for $d = 4$. The achieved throughput is 19.1 Mbps, resulting in an efficiency of approximately 0.11938 bps/Hz¹⁹, which represents an improvement of about 10% as compared to the completely non-overlapping approach (i.e., the $d = 8$ case in Table II). From this and the previous results of this section, we draw the following key conclusions:

- Using non-overlapping channels yields the maximum achievable throughput since interference is completely avoided. Even though this strategy is the one that uses more spectrum, it is nonetheless the one that gives the best spectrum efficiency unless a careful planning of the channel assignment and transmission powers is followed.
- With careful planning, gains in spectrum efficiency of up to about 10% can be achieved by using partially overlapping channels. However, this gain requires substantial planning effort, and unless this effort is made, a better strategy is to use non-overlapping channels.

VI. LESSONS LEARNED

In this section, we enumerate the most important lessons learned from the design, deployment and usage of FloorNet. We divide these lessons in two different categories: *i*) those mostly related to the deployment of the testbed, and *ii*) those related to the results from experimental tests.

A. Testbed deployment

It is feasible to install and operate 802.11-based mesh testbeds under false floors. The first and most important result is that it is possible to deploy wireless 802.11 testbeds under the false floor, and indeed they constitute a valuable research asset. For instance, we demonstrate in Section V how the testbed is used to evaluate a channel configuration algorithm.

802.11 indoor testbeds suffer from interferences, both intra (i.e., neighboring wireless networks) and inter technology (e.g., Bluetooth). This is particularly evident for the case of 802.11b/g WLANs that operate in the over-populated 2.4 GHz band.

External interference measurement or estimation is crucial to understand experimental results. Along with the devices used to perform a given experiment, the deployment of a parallel infrastructure to monitor all the activity in the channel is helpful to understand possible deviations from the expected results.

The false floor provides shielding from external radio sources, which is particularly convenient for the crowded 2.4 GHz band. Despite we believe that the physical protection from the false floor is enough motivation to deploy testbeds like FloorNet, this comes with the added benefit of partial radio isolation.

¹⁹We tried more complex and time-consuming alternatives to Algorithm 1 but we could not find any that provides a significant improvement in terms of efficiency or power consumption. These alternatives consisted on: once the algorithm finishes, 1) repeat the search on the links used to improve the end to end (not hop by hop) throughput performance; 2) repeat the search, but in the backwards direction; 3) repeat the search, but randomly choosing which links have to be reconfigured.

Careful node placement is crucial. The distance between antennae/nodes has to be larger than the far-field threshold to avoid near-field unpredictable effects, which are hard to identify. These issues arise not only for devices using the same physical layer, but also when using 802.11g and 802.11a devices.

Off-the-shelf routers have very limited resources. Note that this has huge impact on (and therefore conditions) the types of tests and measurements that can be conducted in a testbed. For instance, these routers are not powerful enough to generate, process and/or forward frames at some traffic rates.

Wiring also deserves some attention. We found that using cheap Ethernet switches (like common 5 to 8-port home switches) causes unexpected performance drops, such as intermittent disconnections or throughput bottlenecks. Therefore, instead of using cheap switches it is better to spend the money on wiring and use high-performance switches with star-like topologies.

Avoid performing simultaneous tests. Even if the network is partitioned and the devices are physically distant from each other, still there are a few sources of measurement bias. For instance, desktop machines, typically equipped with 100 Mbps Fast Ethernet cards, cannot generate more than approximately 90 Mbps of traffic (depending on the frame size) and therefore cannot saturate more than three 802.11a/g links.

Periodic soft rebooting of the testbed is useful. Off-the-shelf devices are more prone to software bugs and hardware problems, thus their uptimes are typically short, and after some days operating under stressing conditions (e.g., at full forwarding speed) they start to malfunction or even halt. Therefore, it is recommended to perform a soft reboot between series of tests.

Be careful when changing wireless settings, since some particular combinations of the, e.g., `iwconfig` command may not result in the desired configuration. It is therefore very important to verify applied changes and to identify conflicting settings.

Do not always use the same “SSID”. It is better to use different network names every time a new test is initiated or a new network has to be created. Using always the same SSID might cause that several stations remain joined to an old network or re-join it despite a change of frequency, leading to unexpected problems.

B. Operation results

For indoor testing and using COTS devices, it is more convenient to use 802.11a than 802.11g, to generate diverse multihop topologies. By changing the transmission power, the connectivity of some links can be controlled, thus allowing for the generation of diverse multihop topologies without the need of using additional specialized hardware (attenuators) like [35]. Without these, with 802.11g all the testbed is within one hop radio coverage, even for the minimum transmission power.

Asymmetries in bandwidth sharing are quite common and hard to predict. Therefore, conducting fairness measurements is critical to understand performance results deviating from the expected ones. The *capture effect* is quite common in

real deployments [36] and it is one of the main reasons of these anomalies. Only through a careful setting of the transmission power these asymmetries can be lessened.

Single-channel wireless multihop networks provide very low throughput. Note that the throughput obtained in our case is in the same order of magnitude that the one from RoofNet [7], despite we are using a physical layer with higher transmission rates. It is therefore critical to use different channels and to reuse frequencies when possible.

Using non-overlapping channels provide the most efficient use of the spectrum. Despite for some configurations a careful setting of the transmission power can improve the efficiency, the complexity required does not seem to be worth the benefits.

VII. SUMMARY

In this paper we have presented FloorNet, a novel wireless mesh testbed deployed under the false floor that is based on commercial off-the-shelf equipment. We have analyzed and assessed its unique characteristics, that we believe constitute strong support for the deployment of these type of testbeds. First, the false floor provides the testbed with physical protection, a feature that saves a lot of time because of, e.g., the absence of wire disconnections. We believe this feature itself constitutes a major reason for the deployment of testbeds like ours. Second, despite the relatively small size of the deployment, we claim it is a valuable research tool for both the 802.11g and the 802.11a cases. For the case of 802.11g, it constitutes a physically stable research platform to run experiments under the presence of interfering sources. For the case of 802.11a the connectivity of the testbed can be easily controlled through a proper adjustment of the transmission power, this way supporting the creation of a large variety of scenarios.

Along with the description and assessment of the features of our testbed, we have also conducted extensive measurements to derive configuration guidelines for wireless mesh networks, which further validate the usefulness of our testbed. One of the major findings is the non-ideal behavior of off-the-shelf hardware, as seen in both *i*) the impact of the entity generating traffic in the measurements, and in *ii*) the strong interference between (assumed) non-overlapping channels. We have also identified, by means of experimentation in different scenarios, in which circumstances it is possible to optimize the transmission power to, e.g., achieve channel fairness or improve the spectrum efficiency.

ACKNOWLEDGMENTS

The authors would like to thank the anonymous reviewers for their comments to improve the paper. We thank also Francisco Ramos and Miguel Flores for their support in setting up the testbed infrastructure. The research leading to these results has received funding from the European Community's Seventh Framework Programme (FP7/2007-2013) under grant agreement n^o 214994 (CARMEN project). It was also partly funded by the Ministry of Science and Innovation of Spain, under the QUARTET project (TIN2009-13992-C02-01), and

the National Science foundation under project ECE EEC-0313747 001.

REFERENCES

- [1] R. Draves, J. Padhye, and B. Zill, "Routing in Multi-radio, Multi-hop Wireless Mesh Networks," in *Proceedings of the 10th annual international conference on Mobile computing and networking*. ACM New York, NY, USA, 2004, pp. 114–128.
- [2] H. Lundgren, K. Ramachandran, E. Belding-Royer, K. Almeroth, M. Benny, A. Hewatt, A. Touma, and A. Jardosh, "Experiences from the Design, Deployment, and Usage of the UCSB MeshNet Testbed," *IEEE Wireless Communications*, vol. 13, no. 2, pp. 18–29, 2006.
- [3] V. Navda, A. Kashyap, and S. Das, "Design and Evaluation of iMesh: An Infrastructure-mode Wireless Mesh Network," in *Sixth IEEE International Symposium on a World of Wireless Mobile and Multimedia Networks, 2005. WoWMoM 2005, 2005*, pp. 164–170.
- [4] J. De Bruyne, W. Joseph, L. Verloock, and L. Martens, "Evaluation of Link Performance of an Indoor 802.11g Network," in *5th IEEE Consumer Communications and Networking Conference, CCNC 2008*, January 2008.
- [5] P. Serrano, A. De La Oliva, C. J. Bernardos, I. Soto, A. Banchs, and A. Azcorra, "A CARMEN Mesh Experience: Deployment and Results," in *IEEE Workshop on Hot Topics in Mesh Networking, HotMESH'09*, June 2009.
- [6] J. Camp, J. Robinson, C. Steger, and E. Knightly, "Measurement Driven Deployment of a Two-tier Urban Mesh Access Network," in *Proceedings of the 4th international conference on Mobile systems, applications and services*. ACM New York, NY, USA, 2006, pp. 96–109.
- [7] D. Aguayo, J. Bicket, S. Biswas, G. Judd, and R. Morris, "Link-level Measurements from an 802.11b Mesh Network," *SIGCOMM Comput. Commun. Rev.*, vol. 34, no. 4, pp. 121–132, 2004.
- [8] Y. Takahashi, Y. Owada, H. Okada, and K. Mase, "A Wireless Mesh Network Testbed in Rural Mountain Areas," in *Proceedings of the second ACM international workshop on Wireless network testbeds, experimental evaluation and characterization*. ACM New York, NY, USA, 2007, pp. 91–92.
- [9] K. Chebrolu and B. Raman, "FRACTEL: A Fresh Perspective on (Rural) Mesh Networks," in *ACM SIGCOMM Workshop on Networked Systems for Developing Regions, NSDR'07*, August 2007.
- [10] D. Gokhale, S. Sen, K. Chebrolu, and B. Raman, "On the Feasibility of the Link Abstraction in (Rural) Mesh Networks," in *IEEE INFOCOM 2008. The 27th Conference on Computer Communications*, 2008, pp. 61–65.
- [11] B. Raman and K. Chebrolu, "Experiences in Using WiFi for Rural Internet in India," *IEEE Communications Magazine*, vol. 45, no. 1, pp. 104–110, 2007.
- [12] D. Gupta, P. Mohapatra, and C. Chuah, "Efficient Monitoring in Wireless Mesh Networks: Overheads and Accuracy trade-offs," in *5th IEEE International Conference on Mobile Ad Hoc and Sensor Systems, 2008. MASS 2008, 2008*, pp. 13–23.
- [13] Y.-C. Cheng, J. Bellardo, B. P., A. C. Snoeren, G. M. Voelker, and S. Savage, "Jigsaw: Solving the Puzzle of Enterprise 802.11 Analysis," *ACM SIGCOMM Computer Communication Review*, vol. 36, no. 4, 2006.
- [14] X. Li, R. Stewart, S. Murphy, E. Fallon, A. Hanley, and S. Roy, "Performance Evaluation of Meraki Wireless Mesh Networks," *IT&T 2007 General Chairs Letter*, p. 156.
- [15] B. Milic and M. Malek, "Analyzing Large Scale Real-world Wireless Multihop Network," *IEEE Communications Letters*, vol. 11, no. 7, p. 580, 2007.
- [16] K. Kim and K. Shin, "On Accurate Measurement of Link Quality in Multi-hop Wireless Mesh Networks," in *International Conference on Mobile Computing and Networking: Proceedings of the 12th annual international conference on Mobile computing and networking*. Association for Computing Machinery, Inc, One Astor Plaza, 1515 Broadway, New York, NY, 10036-5701, USA., 2006.
- [17] T. He, S. Chan, and C. Wong, "HomeMesh: A Low-Cost Indoor Wireless Mesh for Home Networking," *IEEE Communications Magazine*, p. 80, 2008.
- [18] P. Serrano, M. Zink, and J. Kurose, "Assessing the Fidelity of COTS 802.11 Sniffers," *INFOCOM 2009. The 28th Conference on Computer Communications*. IEEE, April 2009.
- [19] F. Fainelli, "The OpenWrt Embedded Development Framework," in *Free and Open Source Software Developers European Meeting*, 2008.

- [20] M. Lacage, M. Manshaei, and T. Turetli, "IEEE 802.11 Rate Adaptation: A Practical Approach," in *Proceedings of the 7th ACM international symposium on Modeling, analysis and simulation of wireless and mobile systems*. ACM New York, NY, USA, 2004, pp. 126–134.
- [21] C. J. Bernardos, I. Soto, and A. Banchs, *Medium Access Control in Wireless Networks*. Nova Science Publishers, Inc., 2008, ch. IEEE 802.11 Standards.
- [22] M. Bredel and M. Fidler, "A Measurement Study of Bandwidth Estimation in IEEE 802.11 g Wireless LANs Using the DCF," *Lecture Notes in Computer Science*, vol. 4982, p. 314, 2008.
- [23] B. Raman, K. Chebrolu, D. Gokhale, and S. Sen, "On the feasibility of the link abstraction in wireless mesh networks," *IEEE/ACM Trans. Netw.*, vol. 17, no. 2, pp. 528–541, 2009.
- [24] A. Doefexi, S. Armour, B. Lee, A. Nix, and D. Bull, "An Evaluation of the Performance of IEEE 802.11a and 802.11g Wireless Local Area Networks in a Corporate Office Environment," in *IEEE International Conference on Communications, 2003. ICC'03*, vol. 2, 2003.
- [25] C. Cheng, P. Hsiao, H. Kung, and D. Vlah, "Parallel Use of Multiple Channels in Multi-hop 802.11 Wireless Networks," in *Military Communications Conference, 2006. MILCOM 2006*, 2006, pp. 1–9.
- [26] C. Balanis, "Antenna Theory and Design," *John Wiley&Sons, Inc*, pp. 249–347.
- [27] J. Robinson, K. Papagiannaki, C. Diot, X. Guo, and L. Krishnamurthy., "Experimenting with a Multi-Radio Mesh Networking Testbed." in *1st workshop on Wireless Network Measurements (Winmee)*, Riva del Garda, Italy, April 2005.
- [28] P. Fuxjager, D. Valerio, and F. Ricciato, "The Myth of Non-Overlapping Channels: Interference Measurements in IEEE 802.11," in *Proc. Fourth Annual Conference on Wireless on Demand Network Systems and Services WONS07*, 2007, pp. 1–8.
- [29] G. Bianchi, A. D. Stefano, C. Giaconia, L. Scalia, G. Terrazzino, and I. Tinnirello, "Experimental Assessment of the Backoff Behavior of Commercial IEEE 802.11b Network Cards," in *INFOCOM, 2007*, pp. 1181–1189.
- [30] D. Giustiniano, G. Bianchi, L. Scalia, and I. Tinnirello, "An Explanation for Unexpected 802.11 Outdoor Link-level Measurement Results," *INFOCOM 2008. The 27th Conference on Computer Communications. IEEE*, pp. 2432–2440, April 2008.
- [31] J. Padhye, S. Agarwal, V. Padmanabhan, L. Qiu, A. Rao, and B. Zill, "Estimation of Link Interference in Static Multi-hop Wireless Networks," in *Proceedings of the 5th ACM SIGCOMM conference on Internet Measurement*. USENIX Association, 2005, p. 28.
- [32] A. Aziz, D. Starobinski, and P. Thiran, "Elucidating the Instability of Random Access Wireless Mesh Networks," in *Sensor, Mesh and Ad Hoc Communications and Networks, 2009. SECON '09. 6th Annual IEEE Communications Society Conference on*, June 2009, pp. 1–9.
- [33] I. Broustis, K. Papagiannaki, S. Krishnamurthy, M. Faloutsos, and V. Mhatre, "MDG: Measurement-Driven Guidelines for 802.11 WLAN Design," in *Proceedings of the 13th annual ACM international conference on Mobile computing and networking*. ACM New York, NY, USA, 2007, pp. 254–265.
- [34] V. Mhatre, K. Papagiannaki, and F. Baccelli, "Interference Mitigation Through Power Control in High Density 802.11 WLANs," in *IEEE INFOCOM, 2007*.
- [35] Y. Su and T. Gross, "Validation of a Miniaturized Wireless Network Testbed," in *WiNTECH '08: Proceedings of the third ACM international workshop on Wireless network testbeds, experimental evaluation and characterization*. New York, NY, USA: ACM, 2008, pp. 25–32.
- [36] A. Banchs, A. Azcorra, C. García, and R. Cuevas, "Applications and Challenges of the 802.11e EDCA Mechanism: An Experimental Study," *IEEE Network Magazine*, vol. 19, pp. 52 – 58, July and August 2005.